

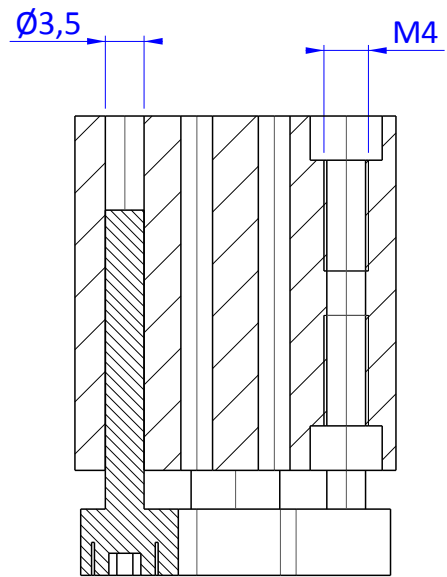

THE PROPERTY OF THE DRAWING IS ESTABLISHED BY LAW. IT IS FORBIDDEN TO PRODUCE OR SHOW IT TO THIRD PART. WITHOUT A WRITTEN AGREEMENT.

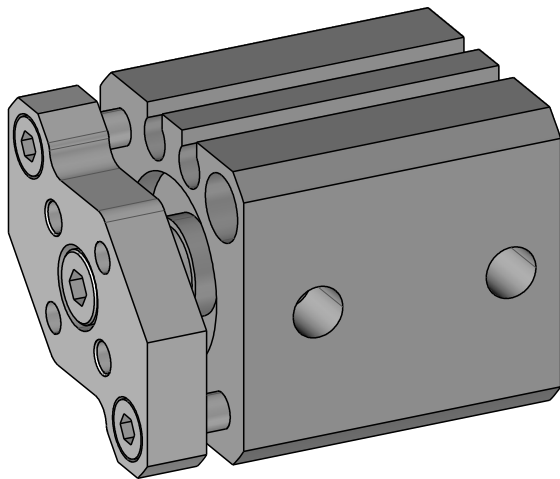
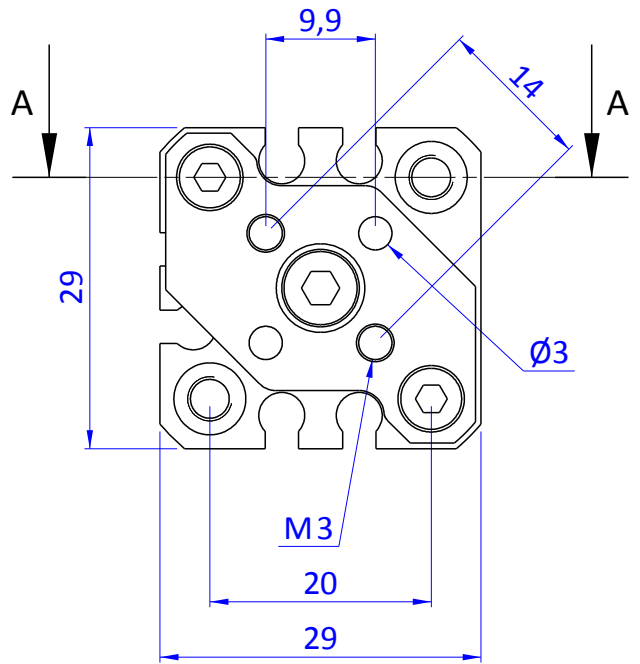
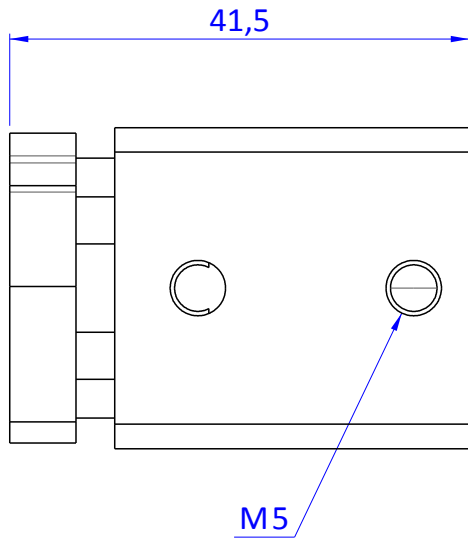

A - A

STROKE = 10 mm

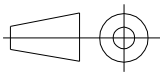
<p>Format A4</p> <p>UNI 936-76</p>	 <p>FPSERVICES AUTOMATION</p>			DESIGNED FROM <b>FPS Automation</b>	REVIEW <b>A</b>
	GENERAL TOLERANCE UNI - ISO 2768 CLASSE f	DESCRIPTION CA.11.17.003		DATE 05/07/2019	WEIGHT 0.077Kg
				CODE CA.11.17.003	